

4U24 Series Server Chassis Product Manual V2.0

CONTENTS

Chapter 1: Product Introduction	02
1.1 Product features	02
1.2 Chassis Structure	03
1.3 Description of Front Panel and Hard Drive Bay	04
1.3.1 Front Panel and Indicator Lights	04
1.3.2 Hard Drive Installation and Hard Drive Tray Indicator Light Instructions	05
1.4 Hard Drive Backplane	06
1.4.1 24-Disk Backplane: 12GB/SAS*8 + Nvme*4	06
Chapter 2: Product Appearance	07
2.1 Chassis Structure	07
2.1.1 Chassis Diagram	07
2.1.2 Server Chassis Images	08
2.1.3 Server Dimensions	09
Chapter 3: Product Loading and Unloading	10
3.1 Removal of the Rear Top Cover	10
3.1.1 Disassembly Steps	10
3.1.2 Installation Steps	10
Chapter 4: Product Loading	11
4.1 Product Packaging	11
Chapter 5: Product and Rail Installation	12
5.1 Install inner rails on both sides of the chassis	12
5.2 The chassis is mounted into the rack	12
Chapter 6: Accessory Name and Part Number	13
6.1 Chassis Accessories List	13
6.2 Optional Accessories List	14

Chapter 1: Product Introduction

1.1 Product Features

Product Code	K24020
Chassis Category	4U Rack mount
Material	SGCC1.2mm(Taiwan)
MB Form Factor	Extended ATX (12"x 13")
Dimensions (D*W*H)	660*435*177(mm) 25.98" x 17.13" x 6.97"
Drive Bays	3.5"Hot-swap: 24 , Internal 2.5": 2 , 2.5"Hot-swap (Option): 2
PSU Form Factor	1+1 Redundant
Indicators	1 * Power Status , 2 * LAN Activity, 1 * UID Status , 1 * HDD Status, 1 Warning Status
Front Control	1 * Power On/Off , 1 * System Reset, 1 * UID 2 * USB 2.0 , USB3.0 + VGA(Optional)
Cooling Fans	Middle: 3 x 120 mm (T=38 mm) 6500 PWM
Expansion Slots	Length or 7 x Low Profile
HDD Backplane	24-port12Gb/s-SAS,-Expander 2-port NVME(Optional) 2-port 12GB(Optional)
Rack rails	P/N:0304100007(Optional)
Net Weight	
Gross Weight	
Package size(D*W*H)	

1.2 Chassis Structure

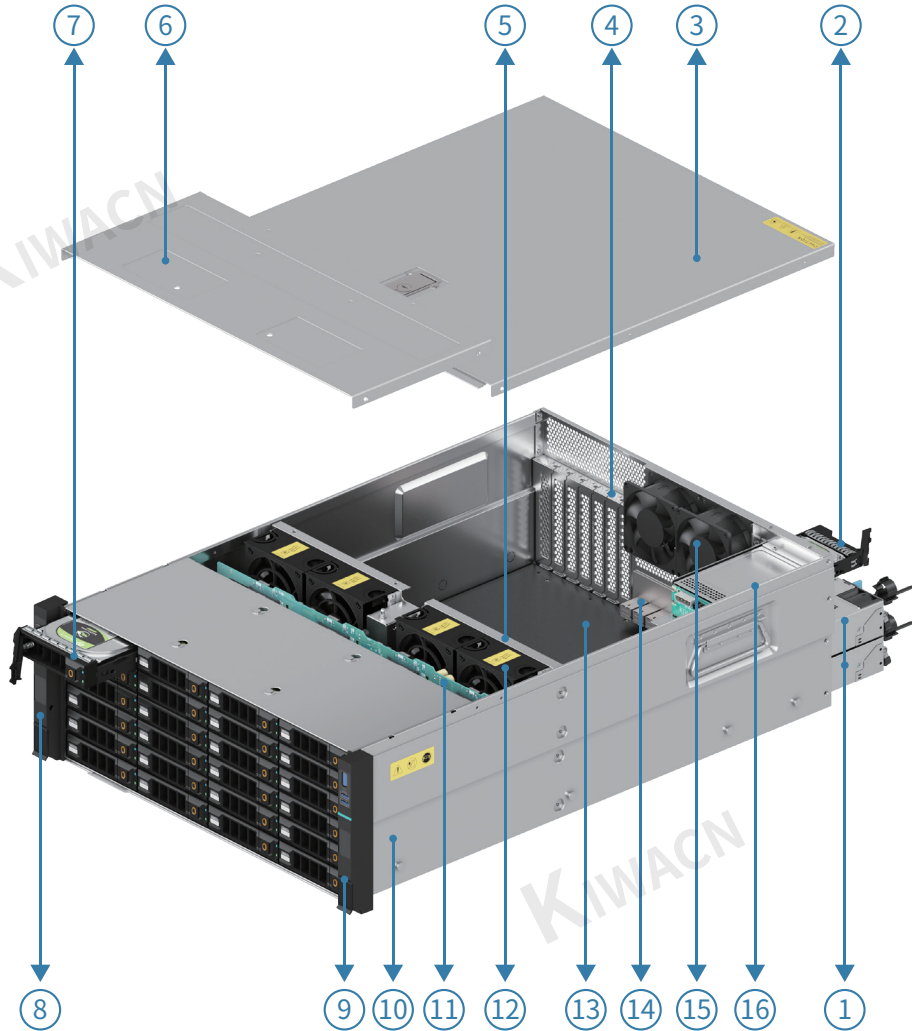

- | | |
|------------------------------------------------------------------|--------------------------|
| 1. Power Supply | 10. Chassis Base |
| 2. 2.5-inch Hard Drive Enclosure Module | 11. Hard Drive Backplane |
| 3. Rear Panel | 12. Cooling fans |
| 4. Standard 7PCIE installation position | 13. Gasket |
| 5. Fans wall | 14. I/O bezel |
| 6. Front Cover | 15. Rear hanging fan |
| 7. 3.5-inch Hard Drive Bracket
(Supports 2.5-inch Hard Drive) | 16. 2.5 Module |
| 8. Left Bracket Assembly(M:Aluminum Alloy) | |
| 9. Right Bracket Assembly(M:Aluminum Alloy) | |

1.3 Description of Front Panel and Hard Drive Bay

1.3.1 Front Panel and Indicator Lights

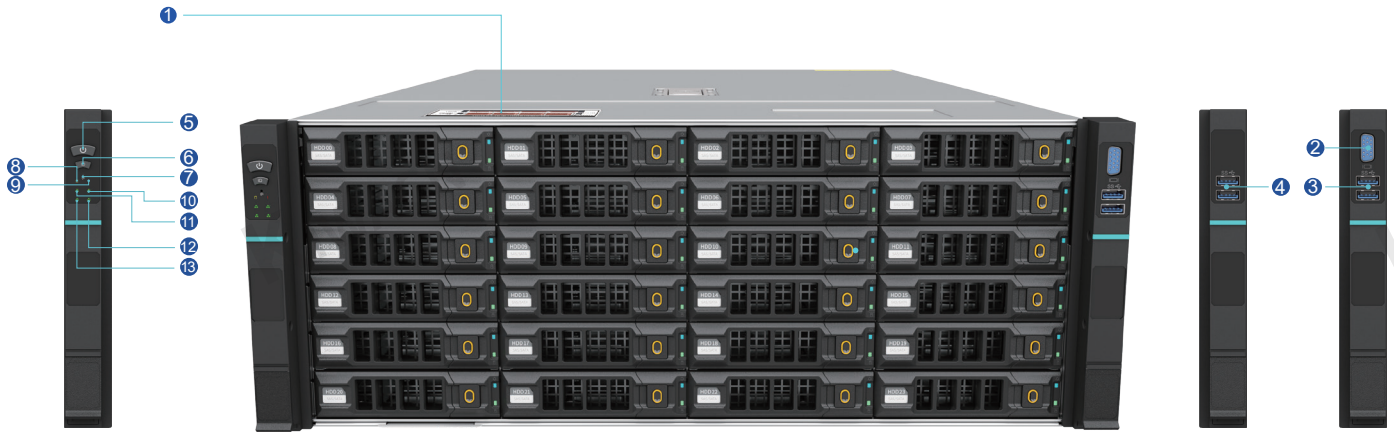

HD00	HD01	HD02	HD03
HD04	HD05	HD06	HD07
HD08	HD09	HD10	HD11
HD12	HD13	HD14	HD15
HD16	HD17	HD18	HD19
HD20	HD21	HD22	HD23

- 1. Server Information Label
- 2. Expand VGA Port
- 3. USB 3.0 x 2
- 4. USB 2.0 x 2
- 5. Power Button + Power Indicator Light
- 6. UID Button + Indicator Light
- 7. Reset Button
- 8. HDD Indicator Light
- 9. Fault Indicator Light
- 10. Ethernet Port 1 Indicator Light
- 11. Ethernet Port 2 Indicator Light

Control Panel Buttons and Interface Description:

Power Button	Power button, press once to power on when the system is powered; In the powered-on state, press and hold for 5 seconds to shut down the system.
Reset Button	In the powered-on state, press once to restart the device.
UID Button	In the powered-on state, press once to illuminate the indicator light.

Control Panel Indicator Light Explanation:

Name	Color	Status	Description
Power Light	Blue	On	The server is in the powered-on state.
UID Light	Blue	On	The server is in the located state.
Fault Indicator Light	Red	On	The server is experiencing a malfunction.
Network 1 Indicator Light	Green	On	The network connection is normal.
Network 2 Indicator Light	Green	On	The network connection is normal.
HDD Indicator Light	Yellow	On	The hard drive is in operational status.

1.3.2 Hard Drive Installation and Hard Drive Tray Indicator Light Instructions:

3.5-inch Hard Drive Installation Guide:

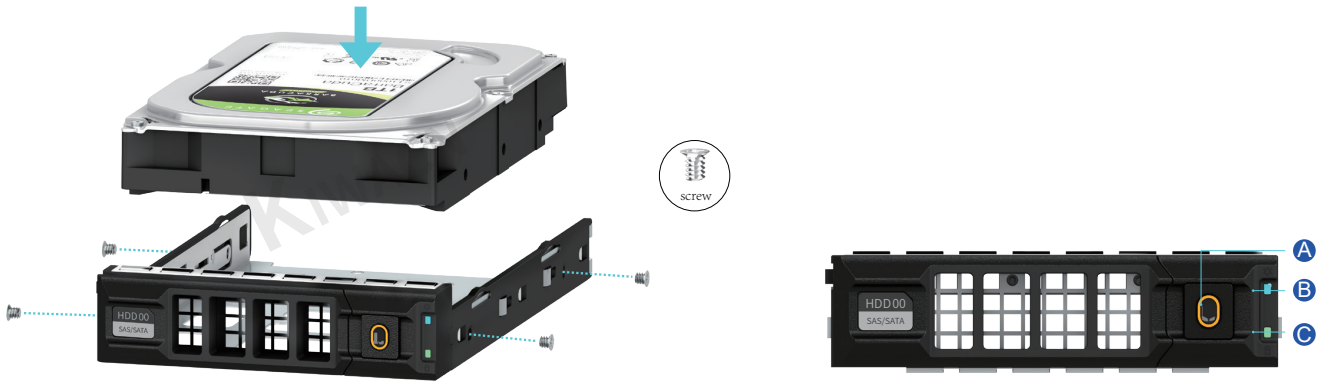

- A. Power On Button
- B. Power Indicator Light
- C. Status Indicator Light

2.5-inch Hard Drive Installation Guide:

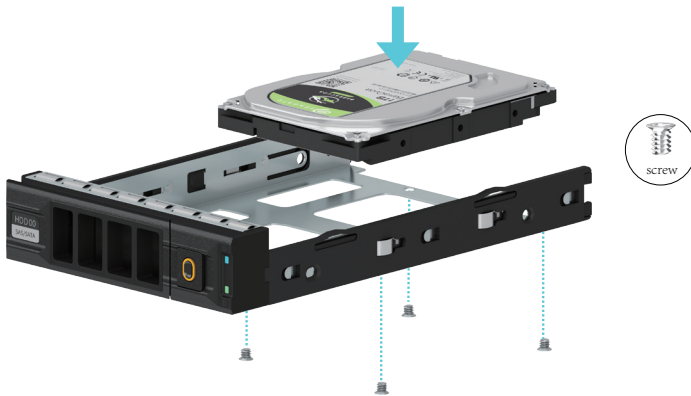

Hard Drive Tray Indicator Light Instructions	
B	Blue: Hard Drive Powered On
	Solid Green: Hard Drive in Position
C	Flashing Green: Hard Drive Activity
	Solid/Flashing Red: Hard Drive Failure

2.5-inch Hard Drive Installation Guide:

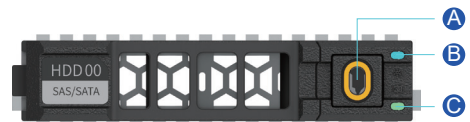
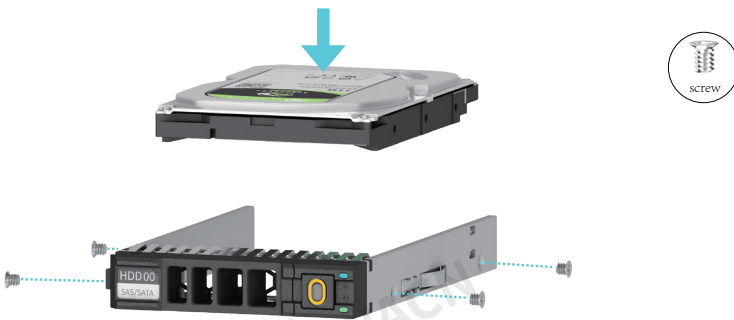

- A. Power On Button
- B. Power Indicator Light
- C. Status Indicator Light

Hard Drive Tray Indicator Light Instructions	
B	Blue: Hard Drive Powered On
	Solid Green: Hard Drive in Position
C	Flashing Green: Hard Drive Activity
	Solid/Flashing Red: Hard Drive Failure

1.4 Hard Drive Backplane

1.4.1 24-disk backplane 12GB/SAS*8 + Nvme*4

TOP PLANE:

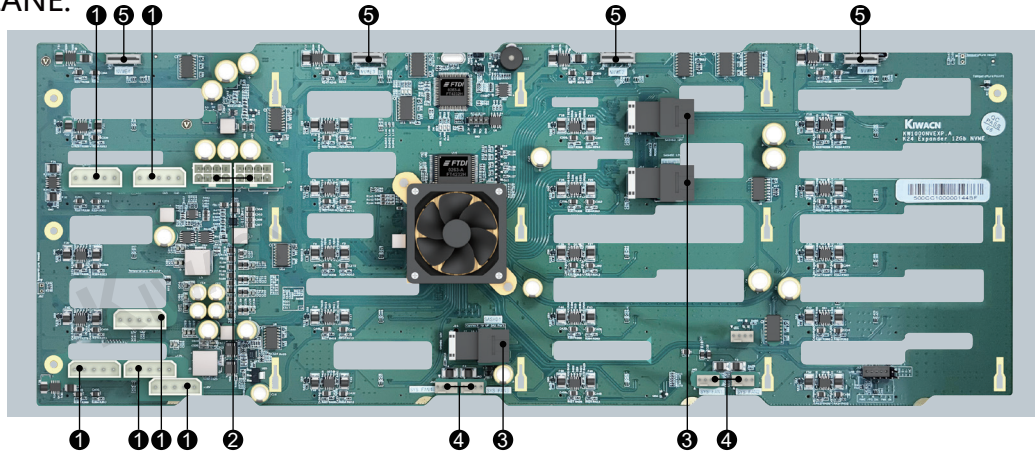

Label	Device Description	Function Description	Function Description
1	ATX 4P Power Connector	Backplane Power Transmission Connector, used for 12V power supply transmission. <i>(Pay attention to the orientation of the interface!!! And do not connect it simultaneously with the large 8-pin connector (③)!!!)</i>	J2, J3, J4, J6, J59, J60
2	8P Power Connector	Backplane Power Transmission Connector, used for 12V power supply transmission <i>Note: Cannot be connected simultaneously with the large 8-pin connector (①)</i>	J5, J58
3	8SFF8643 Connector	Backplane Drive Slot Signal Interface	SASHD1, SASHD2, SASHD3
4	Fan Power Connector	For use with 4-pin fan connector	SYS FAN1, SYS FAN2, SYS FAN3, SYS FAN4
5	Nvme 8611Connector	Nvme 3.0 Connector(Optional)	NVME1, NVME2, NVME3, NVME4

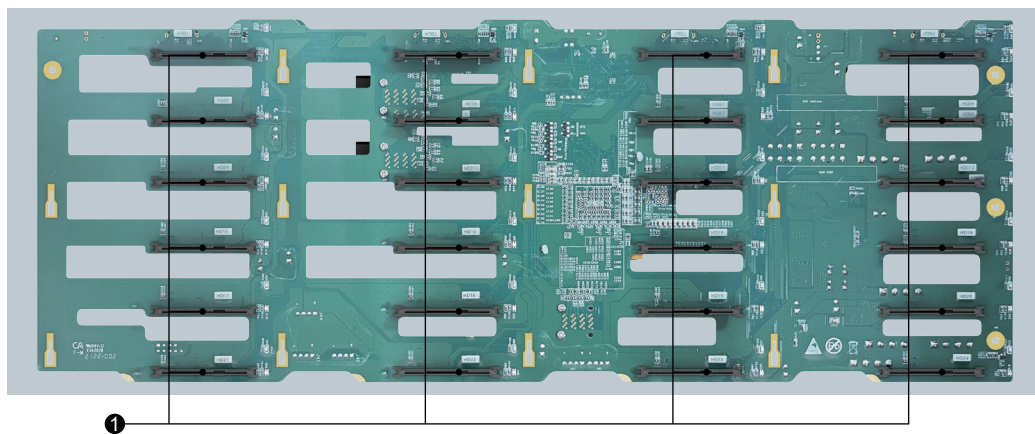

BOTTOM PLANE:

Label	Device Description	Function Description	Function Description
1	SAS/SATA Hard Drive Connector	1.Supports up to 12G/b SAS Hard Drives; 2.Supports up to 6G/b SATA Hard Drives; 3.Supports Hot-Swappable SAS/SATA Hard Drives.	HDD1, HDD2, HDD3, HDD4, HDD5, HDD6, HDD7, HDD8, HDD9, HDD10, HDD11, HDD12, HDD13, HDD14, HDD15, HDD16, HDD17, HDD18, HDD19, HDD20, HDD21, HDD22, HDD23, HDD24

Chapter 2: Product Appearance

2.1 Chassis Structure

2.1.1 Chassis Diagram

4U24:

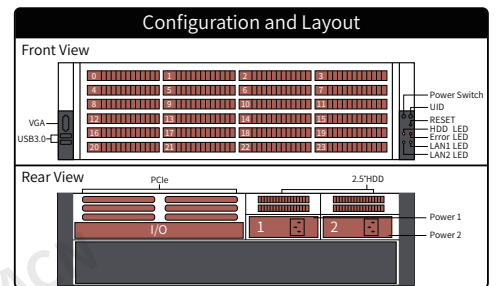
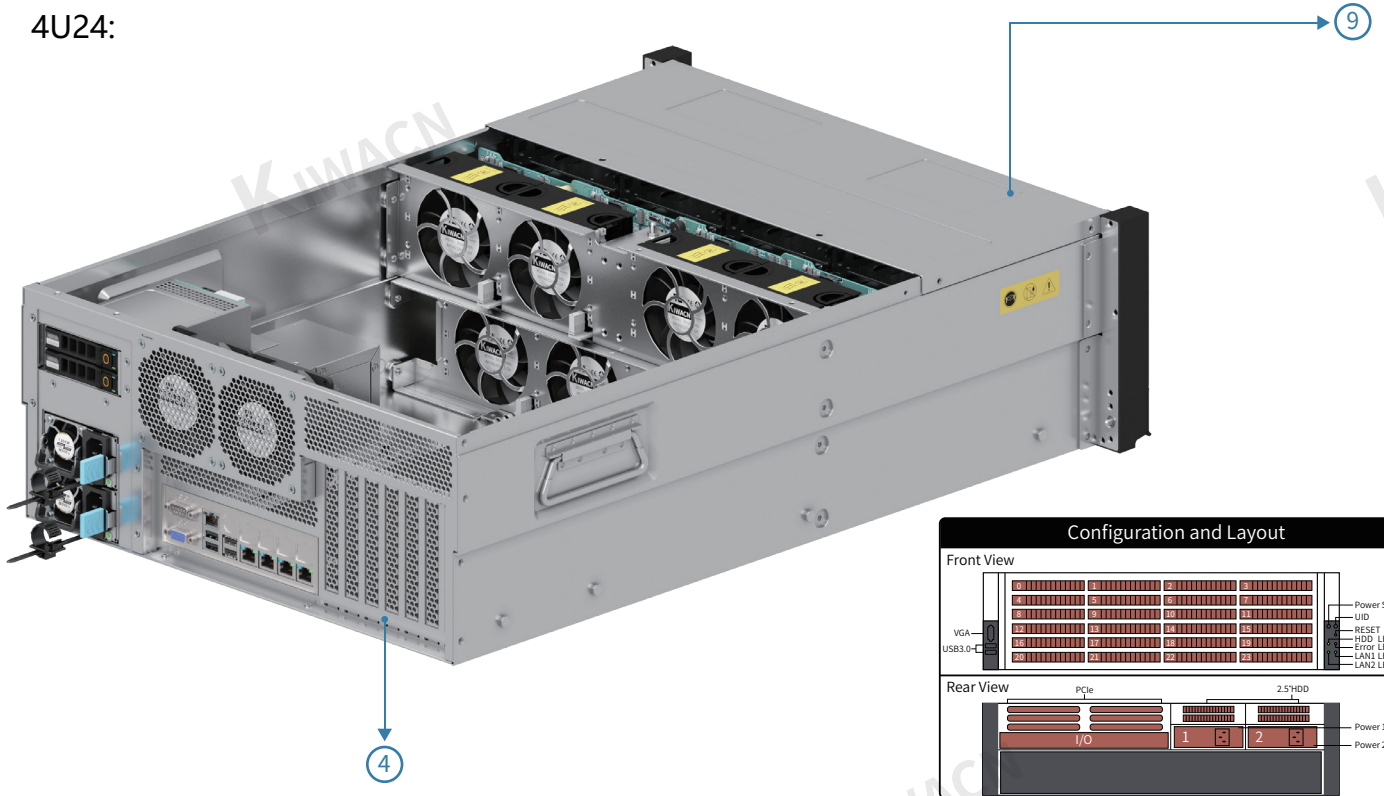

Notice: Caution, High Voltage Hazard



Notice: Caution, High Voltage Hazard

- ② Chassis Layout Diagram Sticker
- ④ Rear Panel



2.1.2 Server Chassis Images



Front View



45° Side View

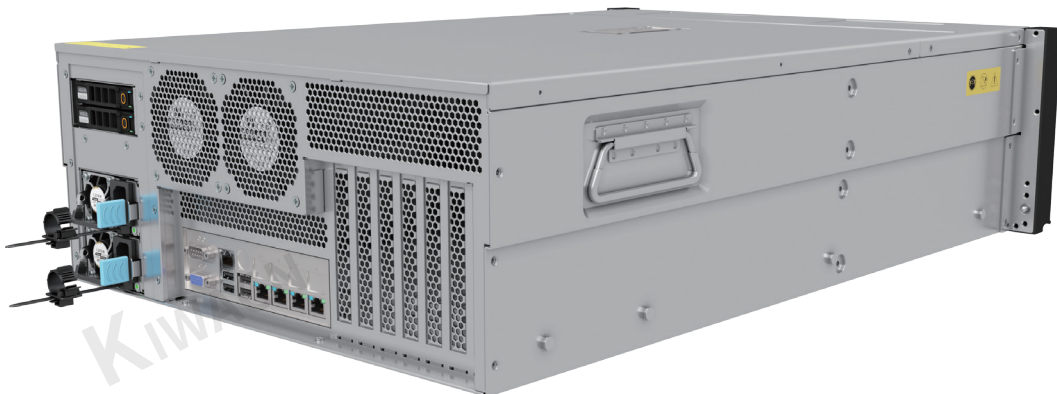

45° Rear View

2.1.3 Server Dimensions

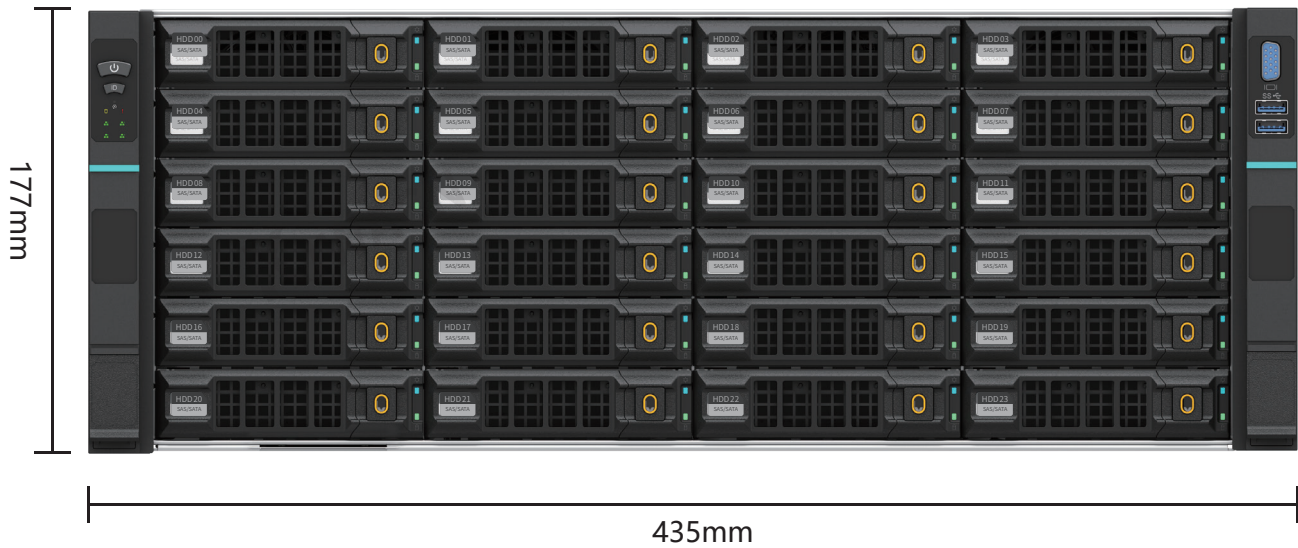

Front View (Dimensions)

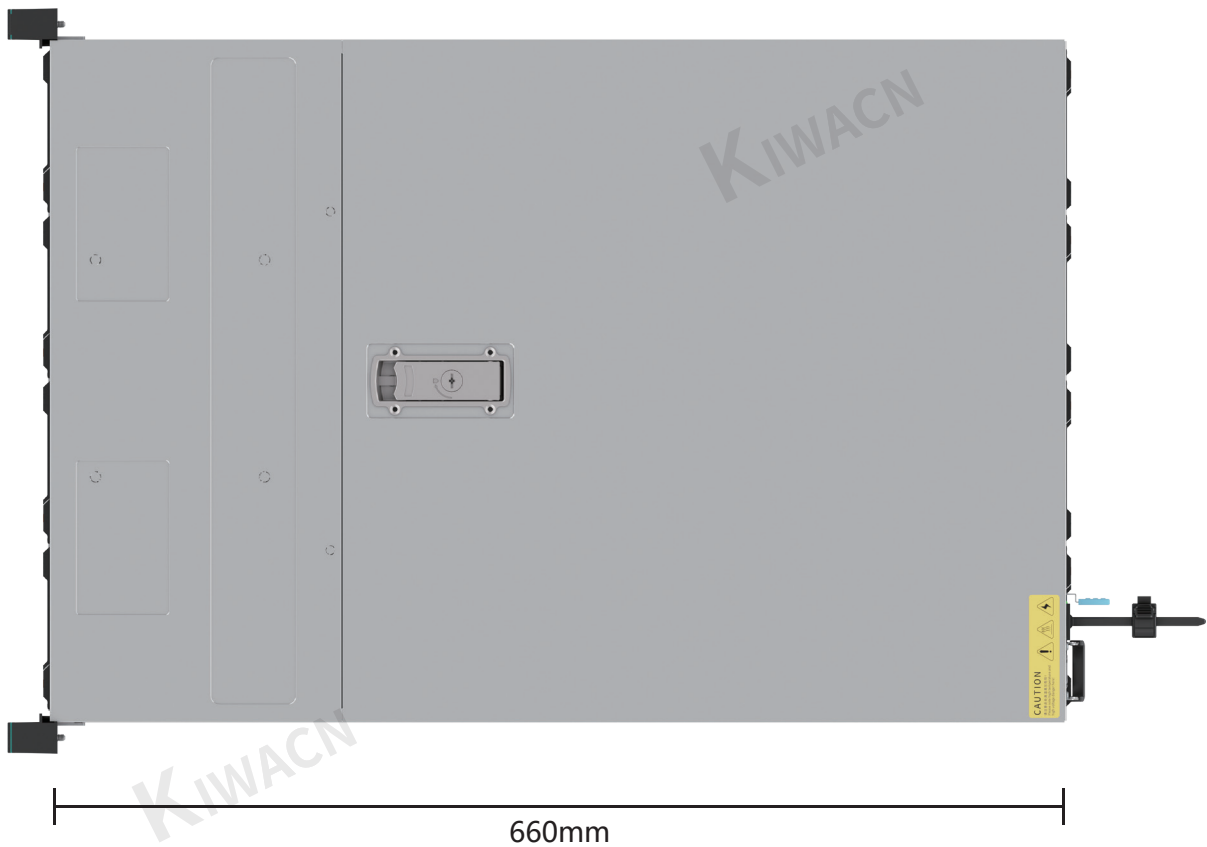

Top View (Dimensions)

Chapter 3 Product Loading and Unloading

3.1 Installation of Optical Drive

3.1.1 Steps of Installing the Optical Drive:

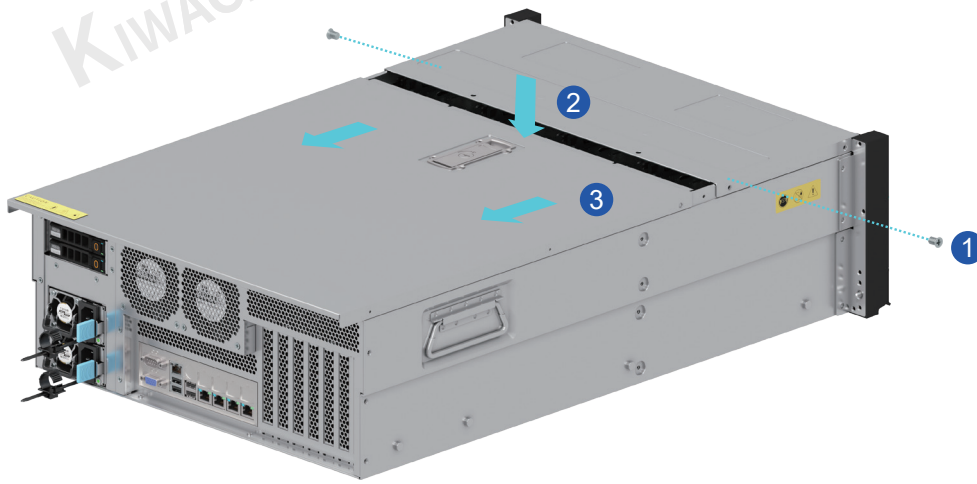

Loosen and remove the screws on both sides in the order shown in the diagram.

Follow the arrow direction to first unlatch and open the lock, then push backward and lift upward to remove the top cover.

3.1.2 Disassembly and assembly steps:

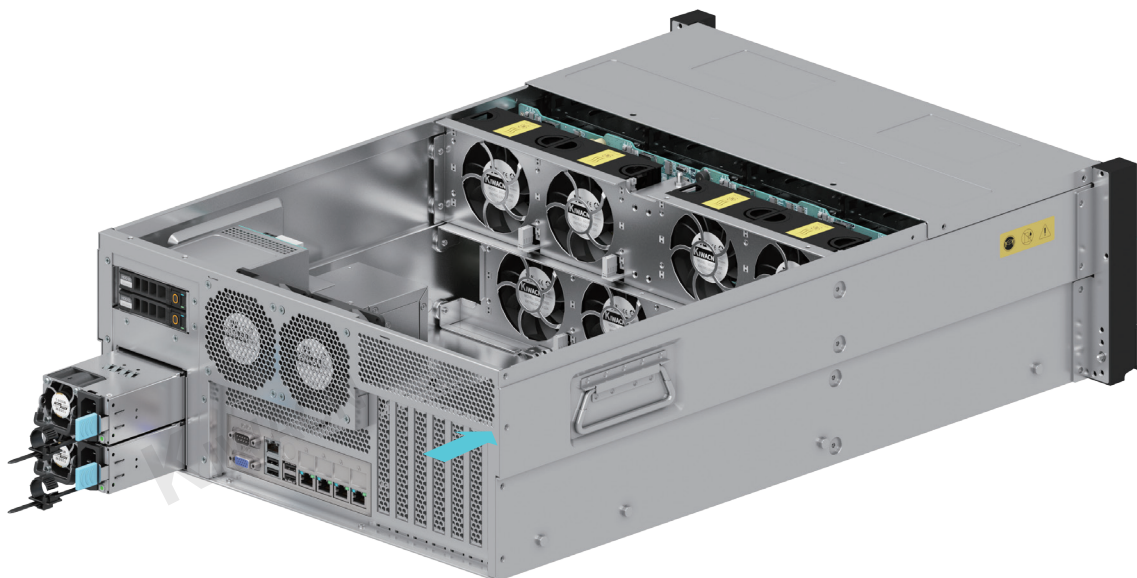

Chapter 4 Product Loading

4.1 Product Packaging

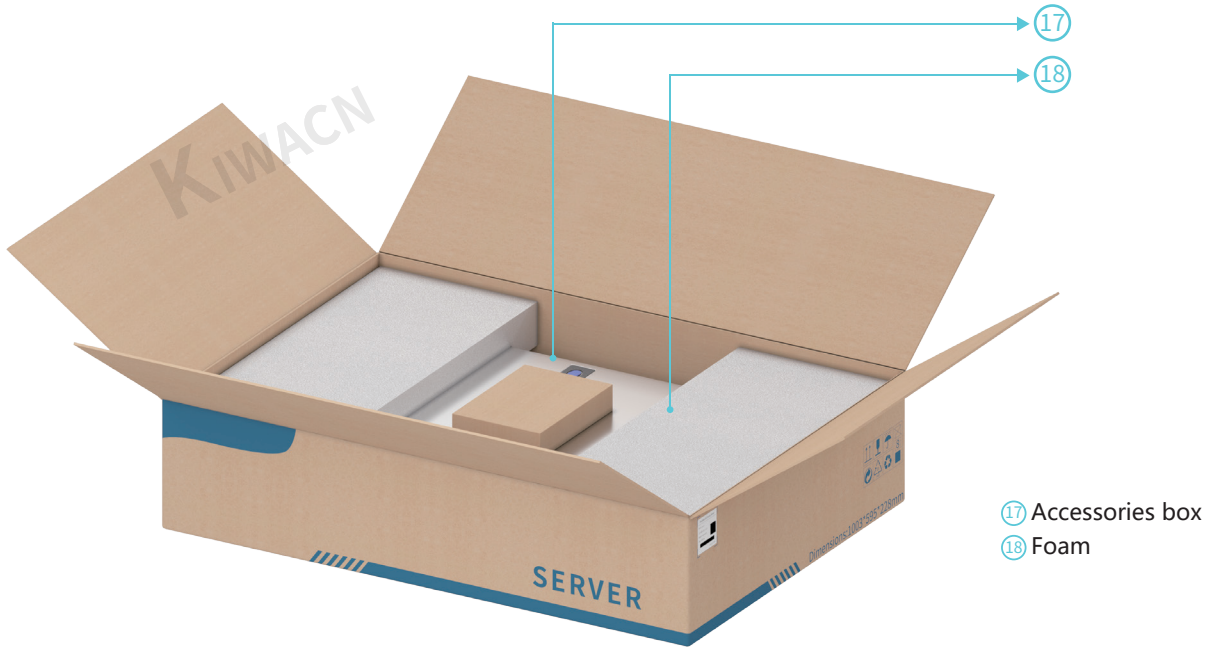

Place it inside the leather suitcase

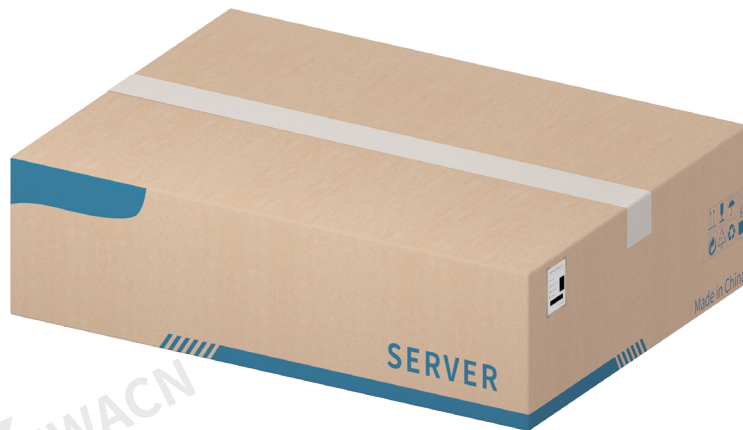

Seal the leather suitcase

Chapter 5 Product and Rail Installation

5.1 Install inner rails on both sides of the chassis

5.1.1 Install and fix the inner guide rail to the side wall of the chassis



5.2 The chassis is mounted into the rack

(Note: Depending on the weight of the chassis, this step requires the cooperation of 2 to 4 people.)

- 5.2.1 First, move the bead seat to the front end of the middle rail, and then insert the inner rail on the chassis horizontally along the G direction.
- 5.2.2 When installing the guide rail, the inner rails on both sides of the server must be kept horizontal and must be inserted simultaneously in the horizontal direction.
- 5.2.3 Make sure that the inner rail enters the guide piece before continuing to push it into the chassis.
- 5.2.4 The chassis can be loosened only after confirming that the inner rail has entered at least halfway.
- 5.2.5 There is a limited bayonet on the inner rail. When pushing in the second section, you need to turn this buckle to enter the third section until it is completely closed.
- 5.2.6 If you find that the inner rail does not enter the bead seat, please repeat the above operation. If necessary, press the auxiliary inner rail with your hands appropriately to enter.
- 5.2.7 Unlock the levers on both sides to push the chassis to the fully closed state. The chassis needs to be fully opened and closed for at least one pull-out process to ensure that the slide rails are installed correctly.

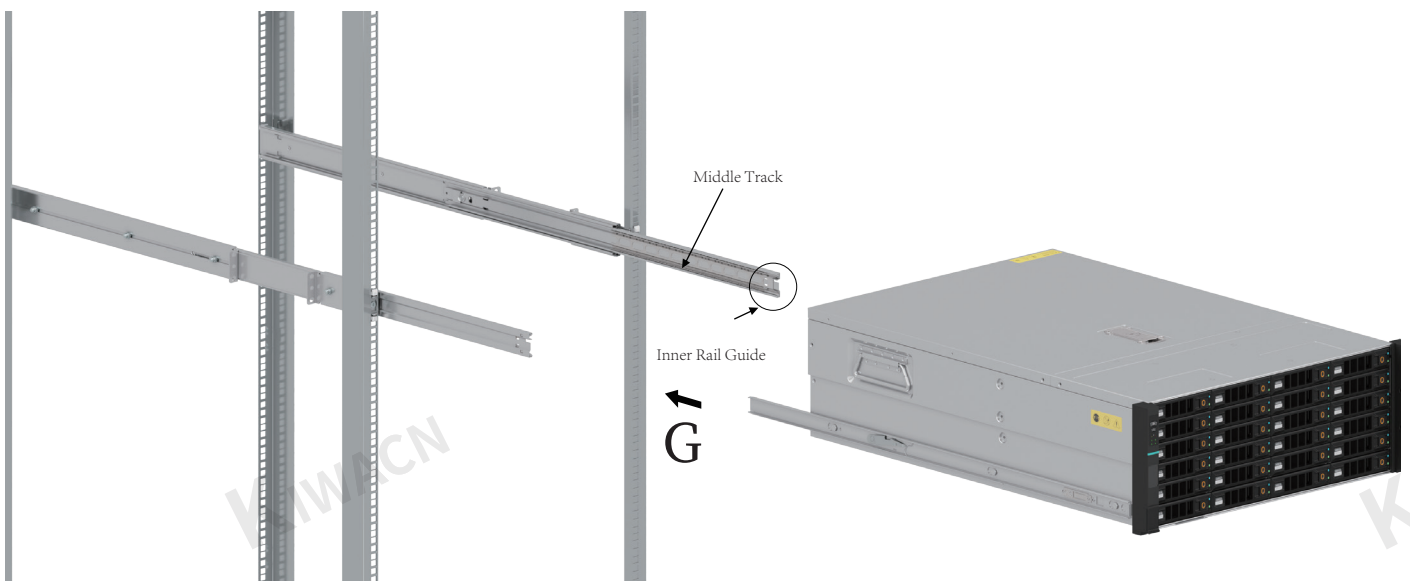

Note: Please be sure to insert it horizontally in this direction, otherwise it will be easily damaged and the slide rail will not slide normally.





Chapter 6 Accessory Name and Part Number

6.1 Accessories and Material Numbers(Parts Box P/N:0201070009)

No.	Part No.	Name	Photograph	Quantity
01	P/N: 0305010001	2.5-inch hard drive screws (Compatible with 3.5-inch hard drive bay)		56
02	P/N:0305010031	3.5inch hard drive screws		48
03	P/N:0305010124	2.5-inch Hard drive retaining screws		4
04	P/N:0305070003	Motherboard heightening column (Motherboard thickness1.6mm)		12
05	P/N:0305010203	Motherboard screws		12
06	P/N:0202110015	2.5Hard drive holder (2U8)		2
07	P/N:0305010125	Fixed single power/ATX		4
08	P/N:0305010025	Fixed redundancy		8
09	P/N:04.02.0009	hard drive sticker (00-11)		1

6.2 Optional Accessories List

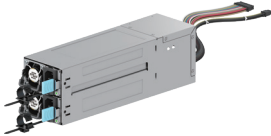
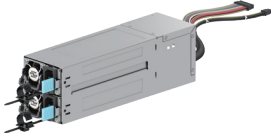
(visit the website for the detail parameter: <https://kiyaworld.com/product/10.html>)

No.	Part Number	Name	Image
01	P/N:0304100006	Slide Rail	
02	P/N:0304090001	8643 Cable	
03	P/N:0304101008	1+1Redundant power moudle (800w)	
04	P/N:0304010018	1+1Redundant power moudle (1200w)	
05	P/N:0201120021	2.5 moudle(nvme)	
06	P/N:0201120006	2.5 moudle(sata)	